

ISOMETRIC

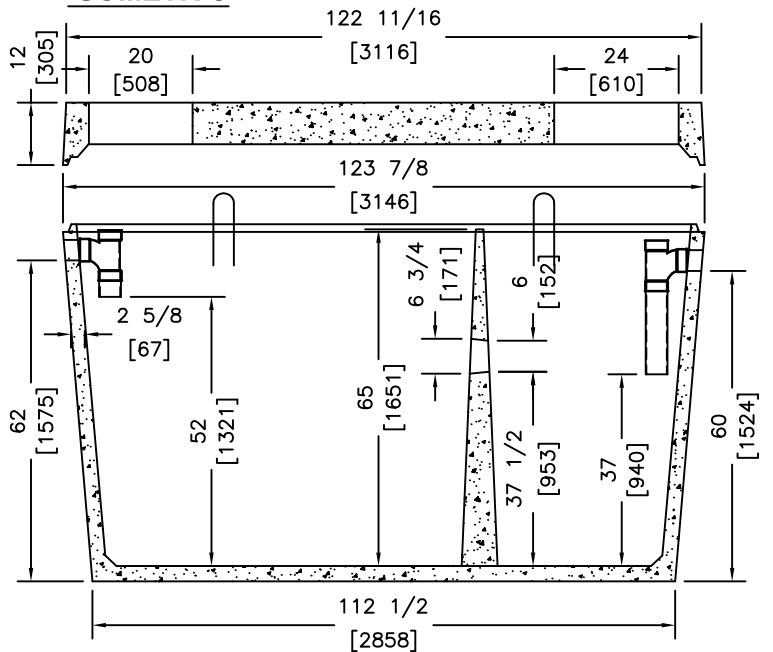

SECTIONS

C.S.A. B-66 LATEST
 32MPa @ 28 DAYS
 TANK: 4236 kg LID: 2929 kg

REVISED: OCT 1 2019



KON KAST
 products (2005) ltd.

ph: (250) 765 1423
 fx: (250) 765 0820
 www.konkast.com

"Committed To Quality And Service"

DESCRIPTION

**1500 GAL (6810L)
 ONE PIECE
 SEPTIC TANK - IND**

DRAWN BY: PKR
 DATE: JUN 20 05
 SCALE: NTS
 DRAWING:

139