

ISOMETRIC

NOTE:
c/w 2-2 3/16" UNI-LIFT
ANCHORS FOR HANDLING

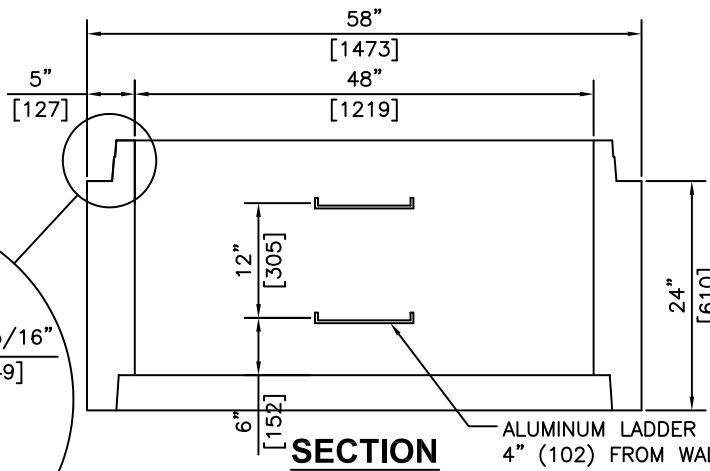

SECTION

ALUMINUM LADDER RUNG MSU MODEL #350
4" (102) FROM WALL AT POINT OF EMBEDMENT

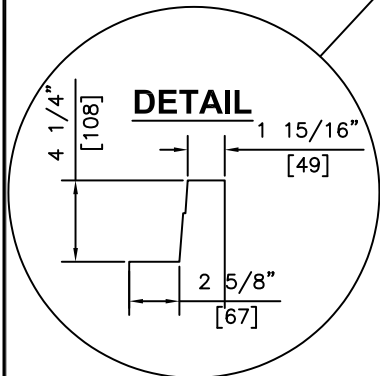

DETAIL

NOTES:

- 1) MEETS OR EXCEEDS ASTM C-478
- 2) 27.6 MPa @ 28 DAYS
- 3) MEETS H-20 LOADING

REVISED: MAR 27 2006



KON KAST
products (2005) Ltd.
"Committed To Quality And Service"

3440 UNIVERSITY WAY
KELOWNA B.C.
V1V 1V9
PH: (250)765-1423
FX: (250)765-0820

BY: PKR
DATE: FEB 7 05
SCALE: NTS

48" (1200) I.D.
x 24" (610) HEIGHT
MANHOLE BARREL

ITEM NO.
751