

SLEEVE SCHEDULE		
POST O.D.	INNER SLEEVE	SLEEVE SIZE IN CONCRETE O.D.
1 1/2"	YES	2"
1 3/4"	YES	2 1/4"
2"	YES	2 1/2"
2 1/4"	NO	2 1/2"

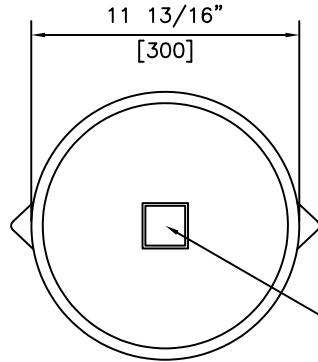

PERFORATED 12 GAUGE GALVANIZED SQUARE STEEL TUBING IS CENTRED IN THE BASE

PLAN

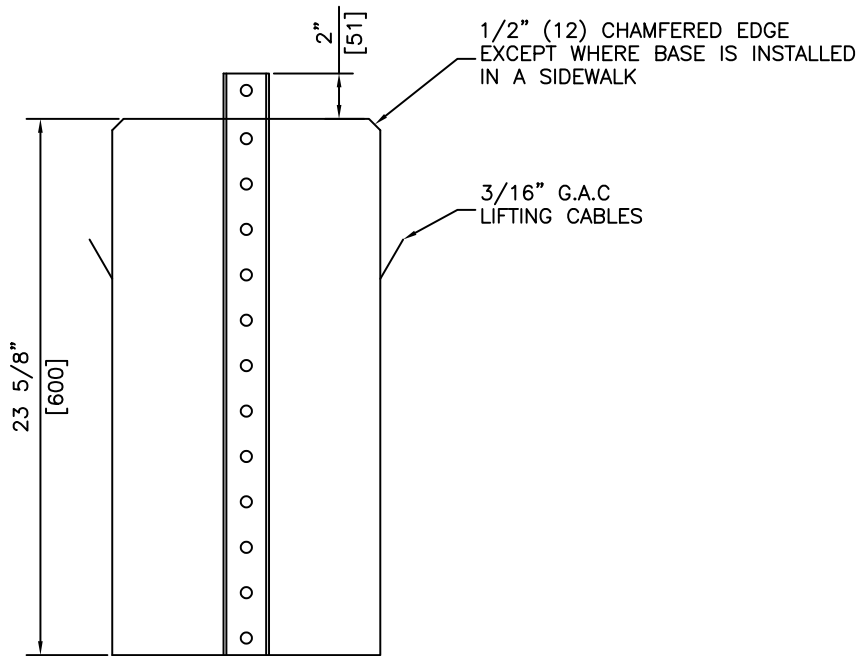

1/2" (12) CHAMFERED EDGE EXCEPT WHERE BASE IS INSTALLED IN A SIDEWALK

3/16" G.A.C LIFTING CABLES

SQUARE STEEL TUBING MAINTAINED THROUGH FOR DRAINAGE

SECTION

NOTES:

1) 30 MPa @ 28 DAYS

REVISED: MAR 1 2005



KON KAST
products (2005) Ltd.
"Committed To Quality And Service"

3440 UNIVERSITY WAY
KELOWNA B.C.
V1V 1V9
PH: (250)765-1423
FX: (250)765-0820

BY: PKR
DATE: MAR 1 05
SCALE: NTS

SP635-1.1.35
TYPE 1
SIGN BASE

ITEM NO.
944