

ISOMETRIC

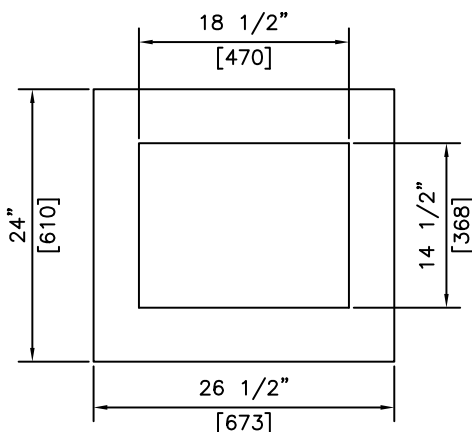

PLAN



SECTION

NOTES:

- 1) MEETS OR EXCEEDS ASTM C478
- 2) 27.6 MPa @ 28 DAYS
- 3) MEETS H-20 LOADING

REVISED: FEB 10 2005



products (2005) Ltd.
"Committed To Quality And Service"

3440 UNIVERSITY WAY
KELOWNA B.C.
V1V 1V9
PH: (250)765-1423
FX: (250)765-0820

BY: PKR
DATE: FEB 10 05
SCALE: NTS

**2" (51) C.B.
GRADE RING
B37 OPENING**

ITEM NO.
810B